

PINT OF SCIENCE BRASIL

As Partículas Quânticas e seus Segredos

Ricardo D'Elia Matheus

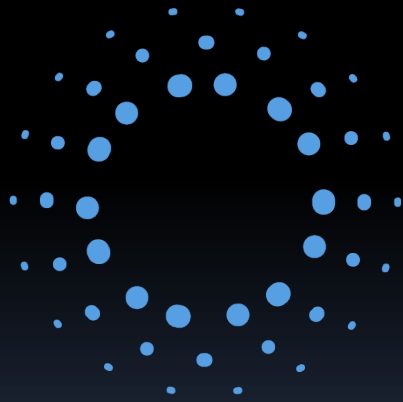

IFT - UNESP
INSTITUTO DE FÍSICA TEÓRICA



Nós quebramos coisas!



Nós quebramos coisas!

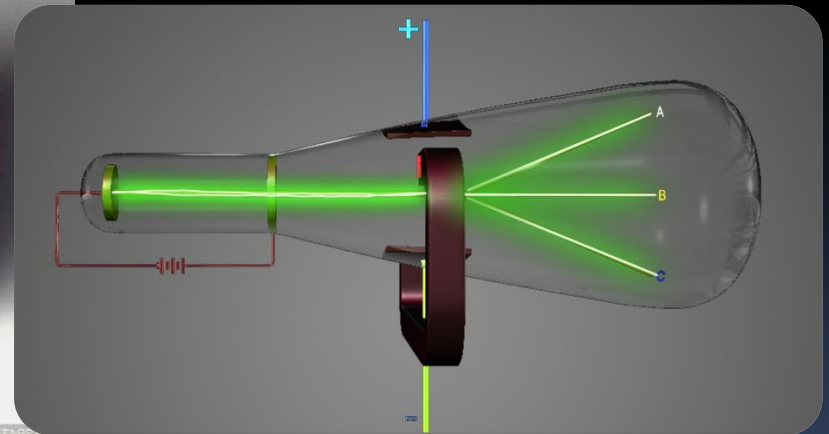
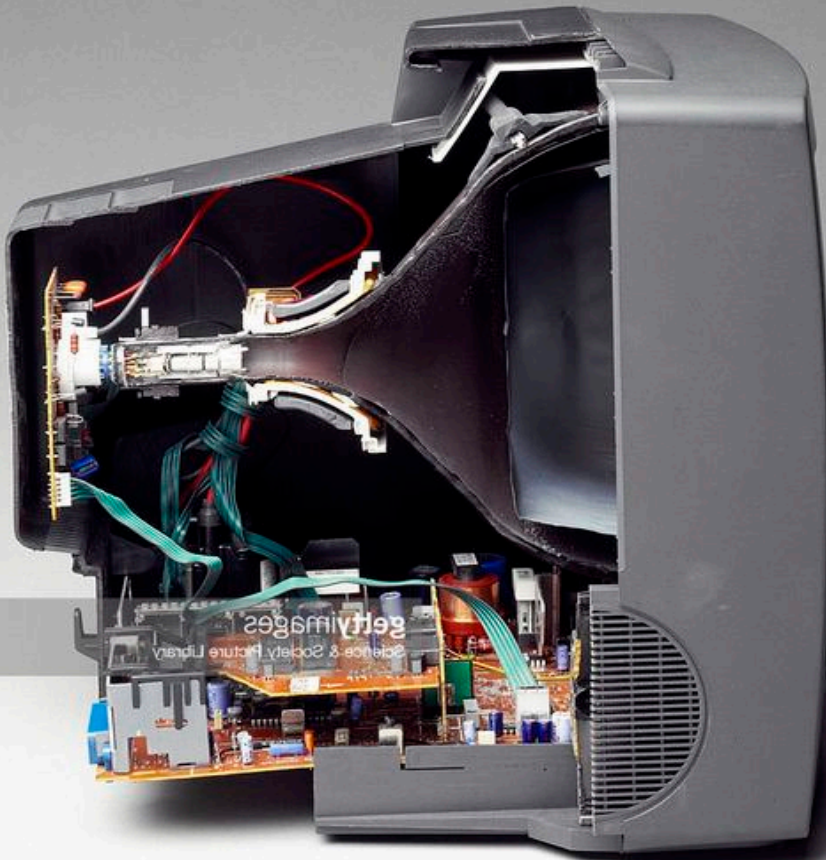

Nós quebramos coisas!

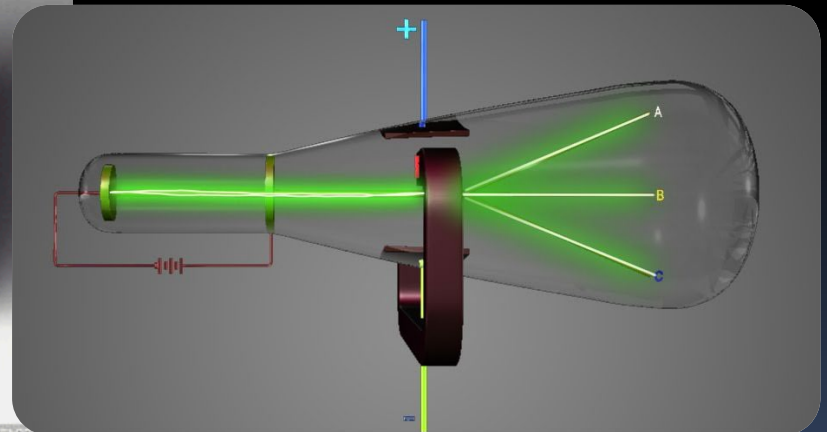
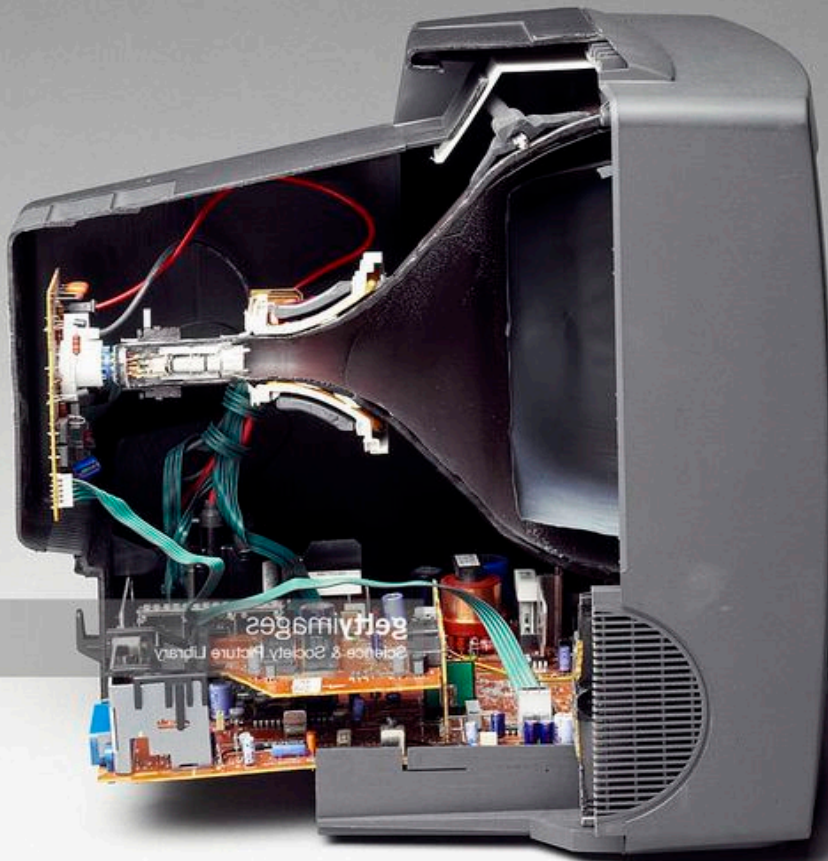

Mas: qual é a curiosidade mesmo?

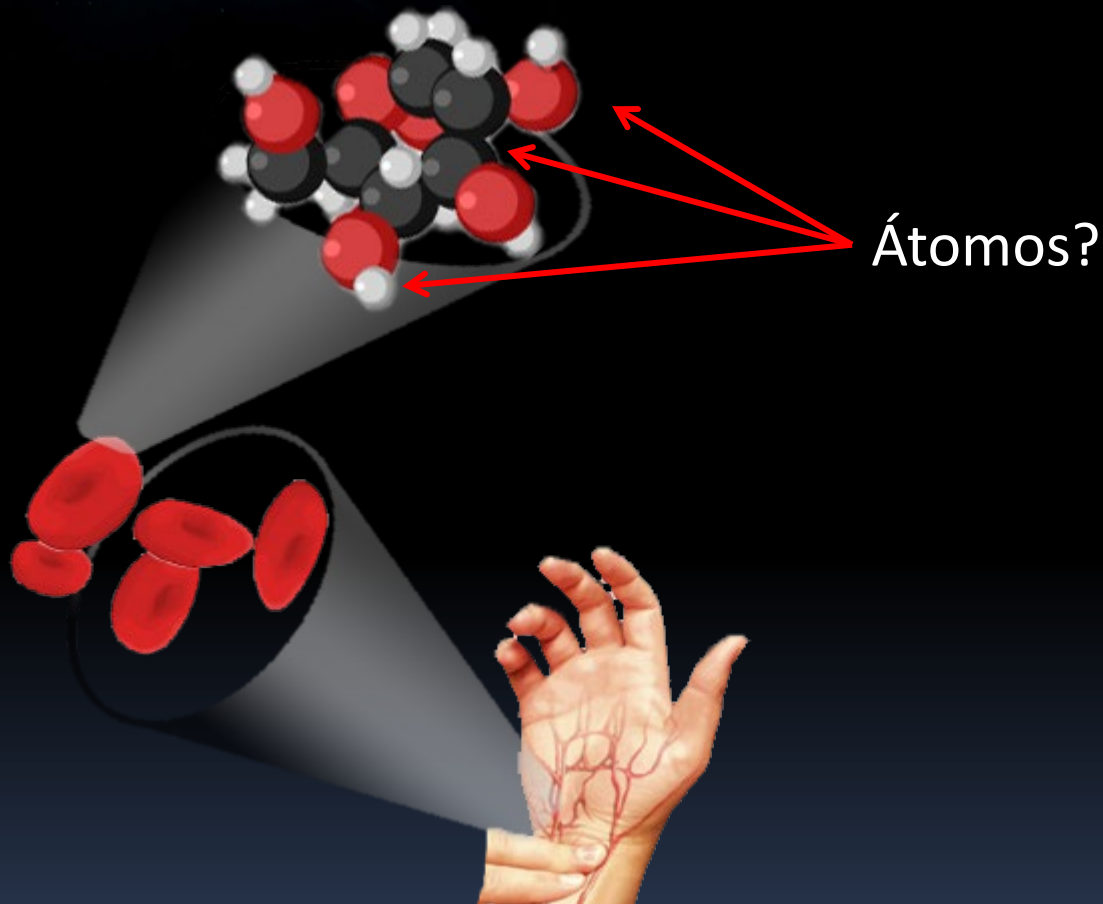

Uma tabela para os “Átomos”

Periodic Table of the Elements

1 H Hydrogen 1.01																	18 He Helium 4.00
3 Li Lithium 6.94	4 Be Beryllium 9.01											5 B Boron 10.81	6 C Carbon 12.01	7 N Nitrogen 14.01	8 O Oxygen 16.00	9 F Fluorine 19.00	10 Ne Neon 20.18
11 Na Sodium 22.99	12 Mg Magnesium 24.31											13 Al Aluminum 26.98	14 Si Silicon 28.09	15 P Phosphorus 30.97	16 S Sulfur 32.06	17 Cl Chlorine 35.45	18 Ar Argon 39.95
19 K Potassium 39.10	20 Ca Calcium 40.08	21 Sc Scandium 44.96	22 Ti Titanium 47.88	23 V Vanadium 50.94	24 Cr Chromium 51.99	25 Mn Manganese 54.94	26 Fe Iron 55.93	27 Co Cobalt 58.93	28 Ni Nickel 58.69	29 Cu Copper 63.55	30 Zn Zinc 65.39	31 Ga Gallium 69.73	32 Ge Germanium 72.61	33 As Arsenic 74.92	34 Se Selenium 78.09	35 Br Bromine 79.90	36 Kr Krypton 84.80
37 Rb Rubidium 84.49	38 Sr Strontium 87.62	39 Y Yttrium 88.91	40 Zr Zirconium 91.22	41 Nb Niobium 92.91	42 Mo Molybdenum 95.94	43 Tc Technetium 98.91	44 Ru Ruthenium 101.07	45 Rh Rhodium 102.91	46 Pd Palladium 106.42	47 Ag Silver 107.87	48 Cd Cadmium 112.41	49 In Indium 114.82	50 Sn Tin 118.71	51 Sb Antimony 121.76	52 Te Tellurium 127.6	53 I Iodine 126.90	54 Xe Xenon 131.29
55 Cs Cesium 132.91	56 Ba Barium 137.33	57-71 Lanthanides	72 Hf Hafnium 178.49	73 Ta Tantalum 180.95	74 W Tungsten 183.85	75 Re Rhenium 186.21	76 Os Osmium 190.23	77 Ir Iridium 192.22	78 Pt Platinum 195.08	79 Au Gold 196.97	80 Hg Mercury 200.59	81 Tl Thallium 204.38	82 Pb Lead 207.20	83 Bi Bismuth 208.98	84 Po Polonium [208.98]	85 At Astatine 209.98	86 Rn Radon 222.02
87 Fr Francium 223.02	88 Ra Radium 226.03	89-103 Actinides	104 Rf Rutherfordium [261]	105 Db Dubnium [262]	106 Sg Seaborgium [266]	107 Bh Bohrium [264]	108 Hs Hassium [269]	109 Mt Meitnerium [268]	110 Ds Darmstadtium [269]	111 Rg Roentgenium [272]	112 Cn Copernicium [277]	113 Uut Ununtrium unknown	114 Fl Flerovium [289]	115 Uup Ununpentium unknown	116 Lv Livermorium [298]	117 Uus Ununseptium unknown	118 Uuo Ununoctium unknown
			57 La Lanthanum 138.91	58 Ce Cerium 140.12	59 Pr Praseodymium 140.91	60 Nd Neodymium 144.24	61 Pm Promethium 144.91	62 Sm Samarium 150.36	63 Eu Europium 151.97	64 Gd Gadolinium 157.25	65 Tb Terbium 158.93	66 Dy Dysprosium 162.50	67 Ho Holmium 164.93	68 Er Erbium 167.26	69 Tm Thulium 168.93	70 Yb Ytterbium 173.04	71 Lu Lutetium 174.97
			89 Ac Actinium 227.03	90 Th Thorium 232.04	91 Pa Protactinium 231.04	92 U Uranium 238.03	93 Np Neptunium 237.05	94 Pu Plutonium 244.06	95 Am Americium 243.06	96 Cm Curium 247.07	97 Bk Berkelium 247.07	98 Cf Californium 251.08	99 Es Einsteinium [254]	100 Fm Fermium 257.10	101 Md Mendelevium 258.10	102 No Nobelium 259.10	103 Lr Lawrencium [262]

- Alkali Metal
- Alkaline Earth
- Transition Metal
- Basic Metal
- Semimetal
- Nonmetal
- Halogen
- Noble Gas
- Lanthanide
- Actinide

©2011 Todd Helmenstine scienceline.com

Como “olhamos” coisas tão pequenas?

Vamos botando para quebrar:

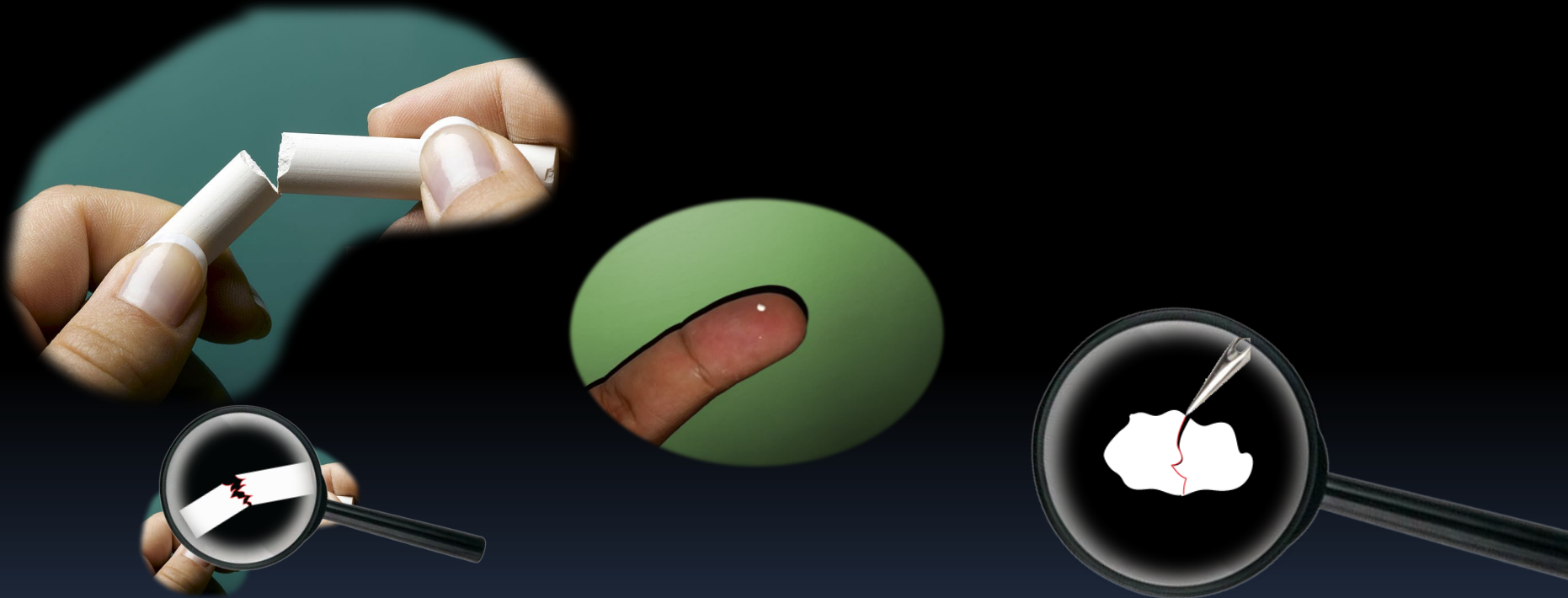

Precisamos colocar **muita energia** em um volume **muito pequeno!**

Acelerando partículas!

Podemos usar como a “ponta da nossa agulha” uma partícula:

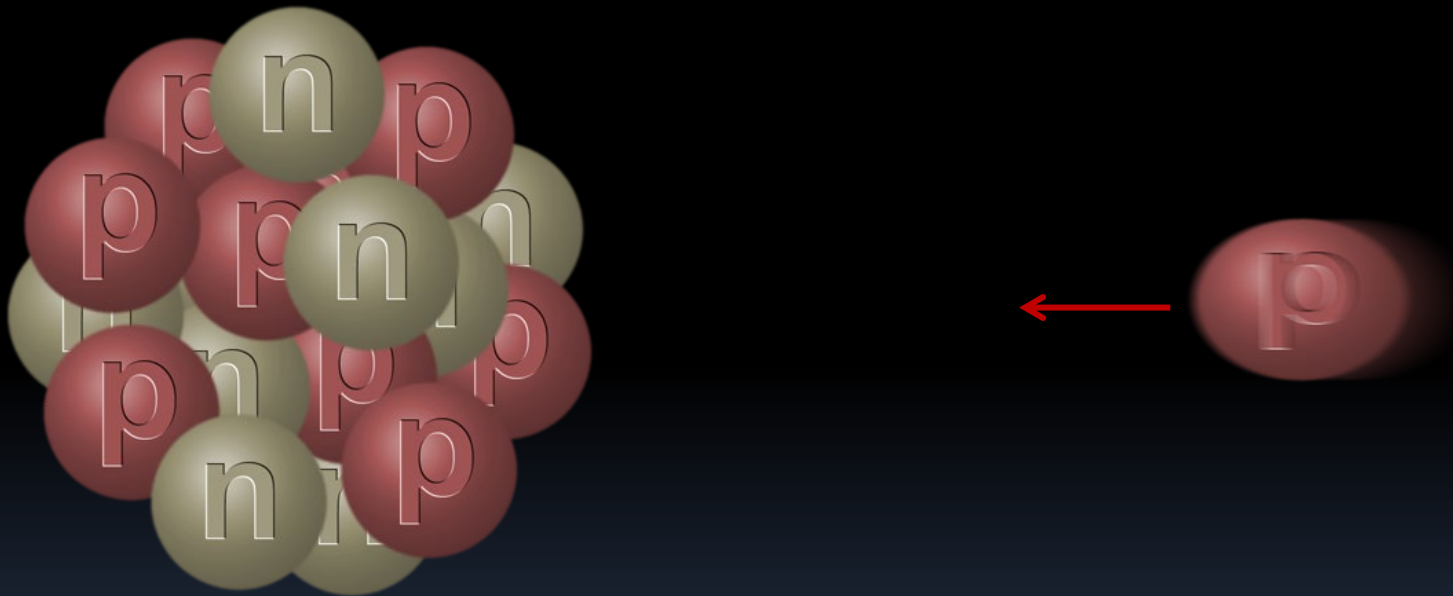

E como acelerar?

A maior máquina já construída: o Large Hadron Collider (LHC)

Circunferência: 26,7 km; Diâmetro 3,8 m
Profundidade : ~ 70-140 m

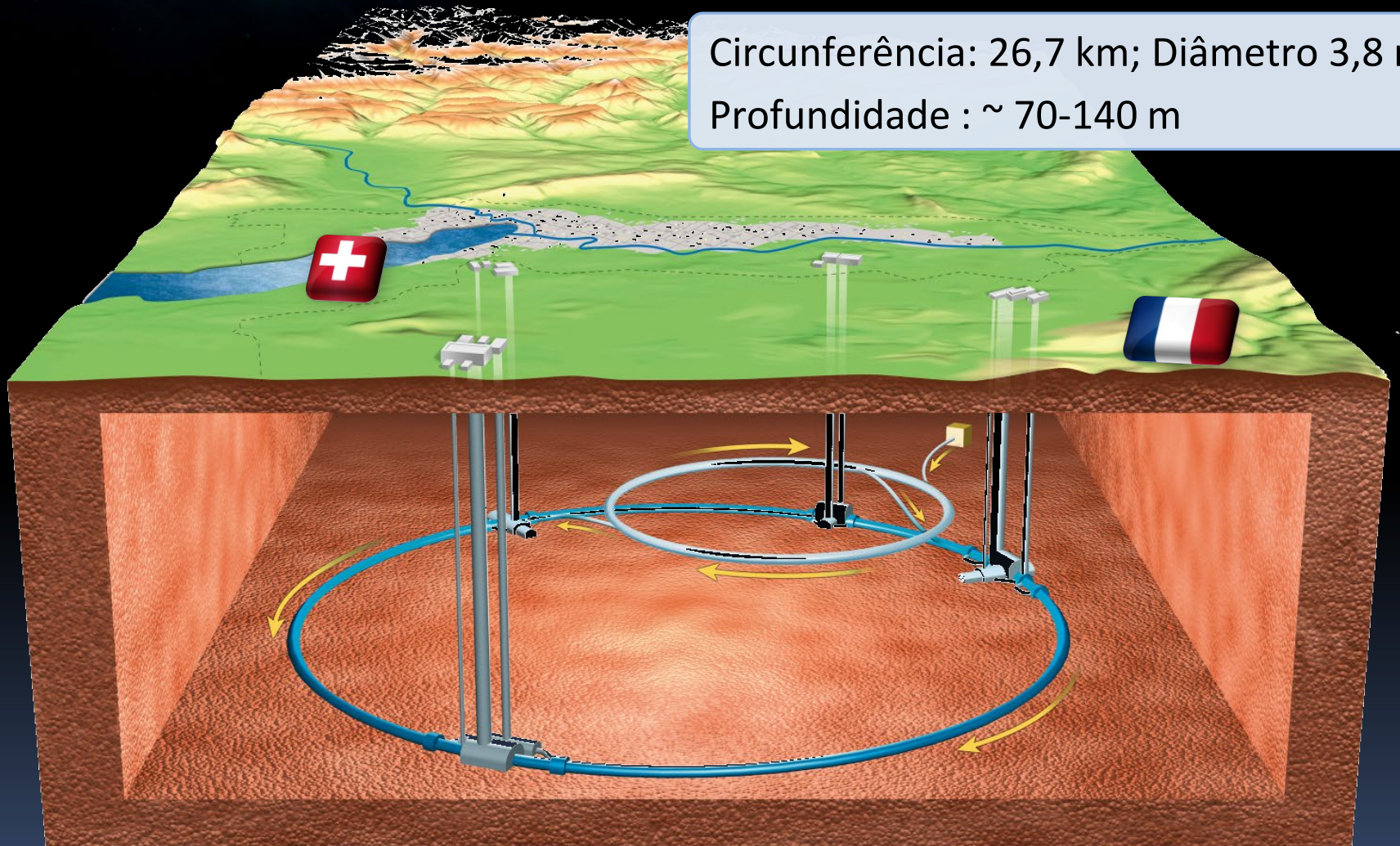

O LHC (Large Hadron Collider)

A maior máquina já construída: o LHC

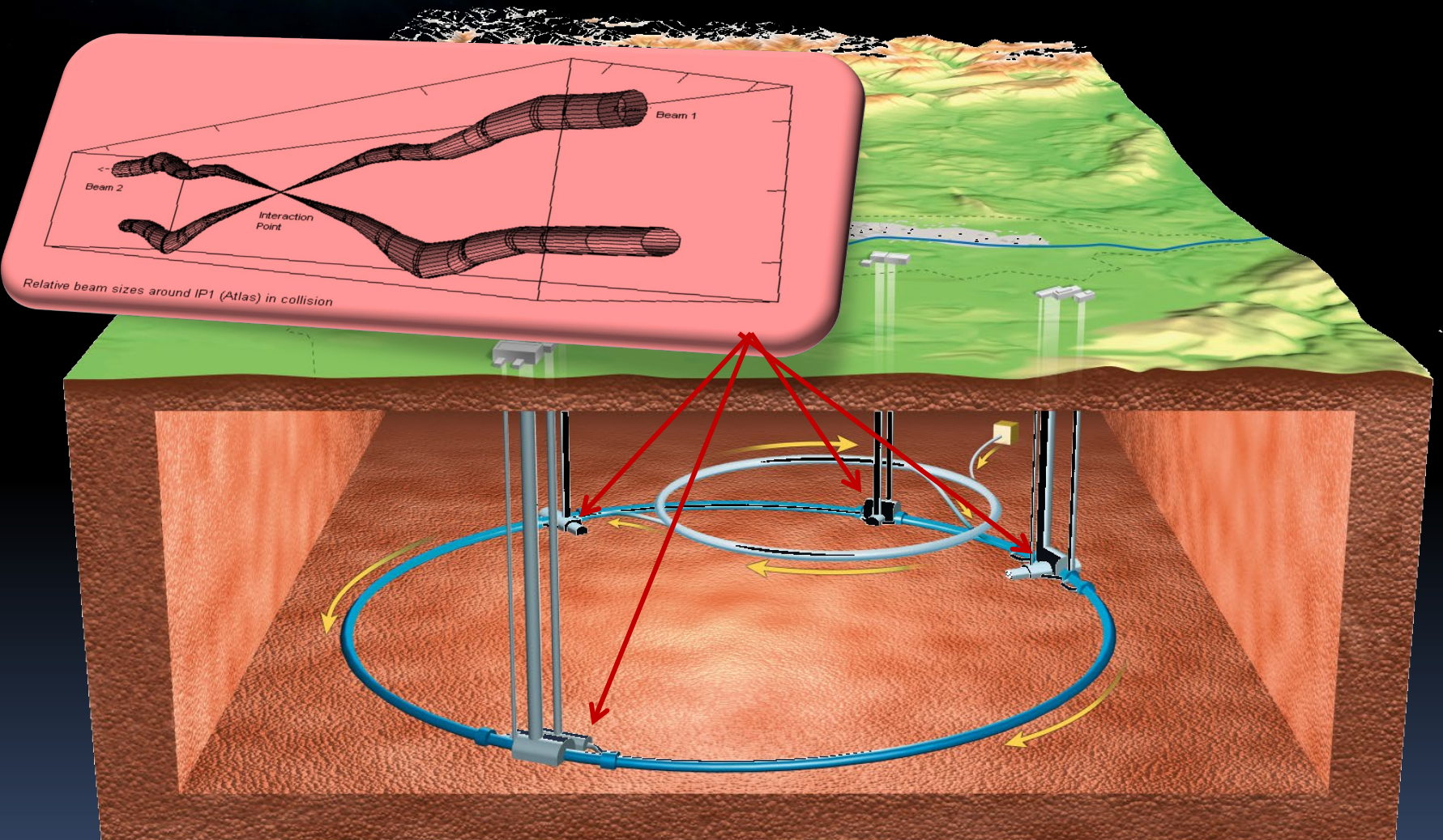

O LHC (Large Hadron Collider)

A maior máquina já construída: o LHC

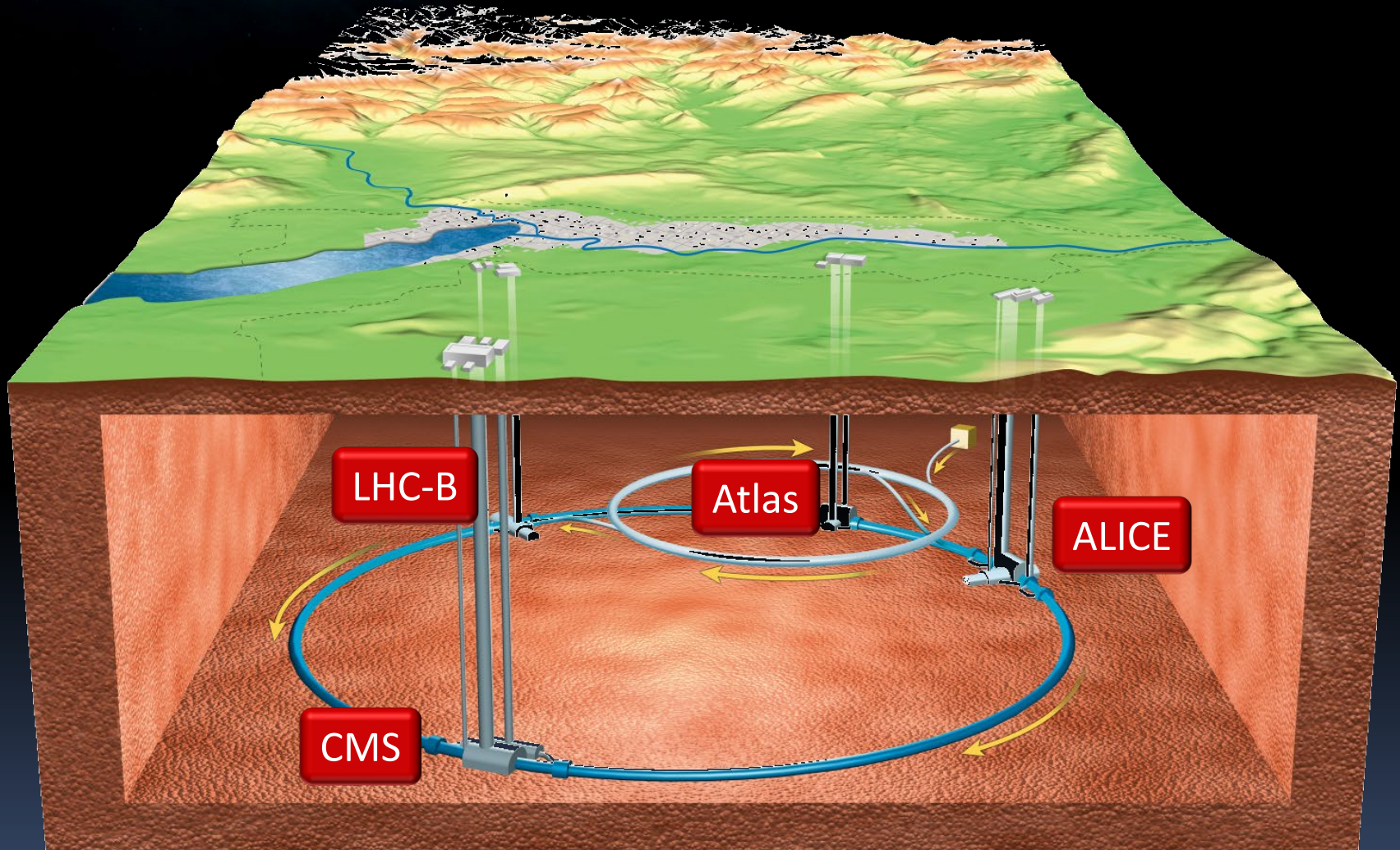

O LHC (Large Hadron Collider)

A maior máquina já construída: o LHC

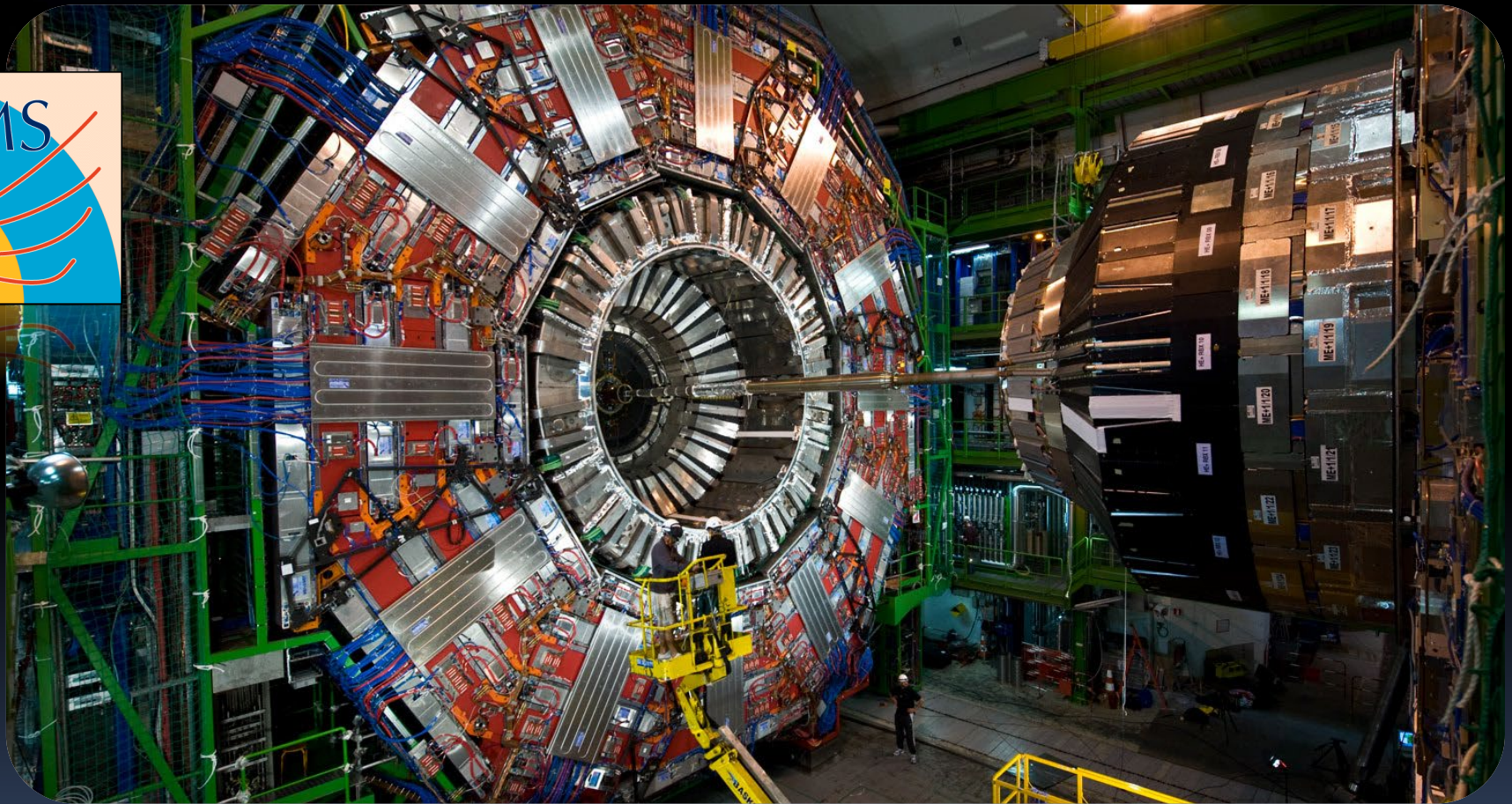

O LHC (Large Hadron Collider)

A maior máquina já construída: o LHC



Encontrando partículas

Procuramos eventos como o abaixo:

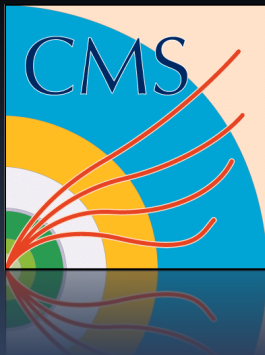
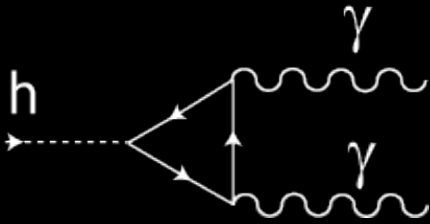

25/10/2018

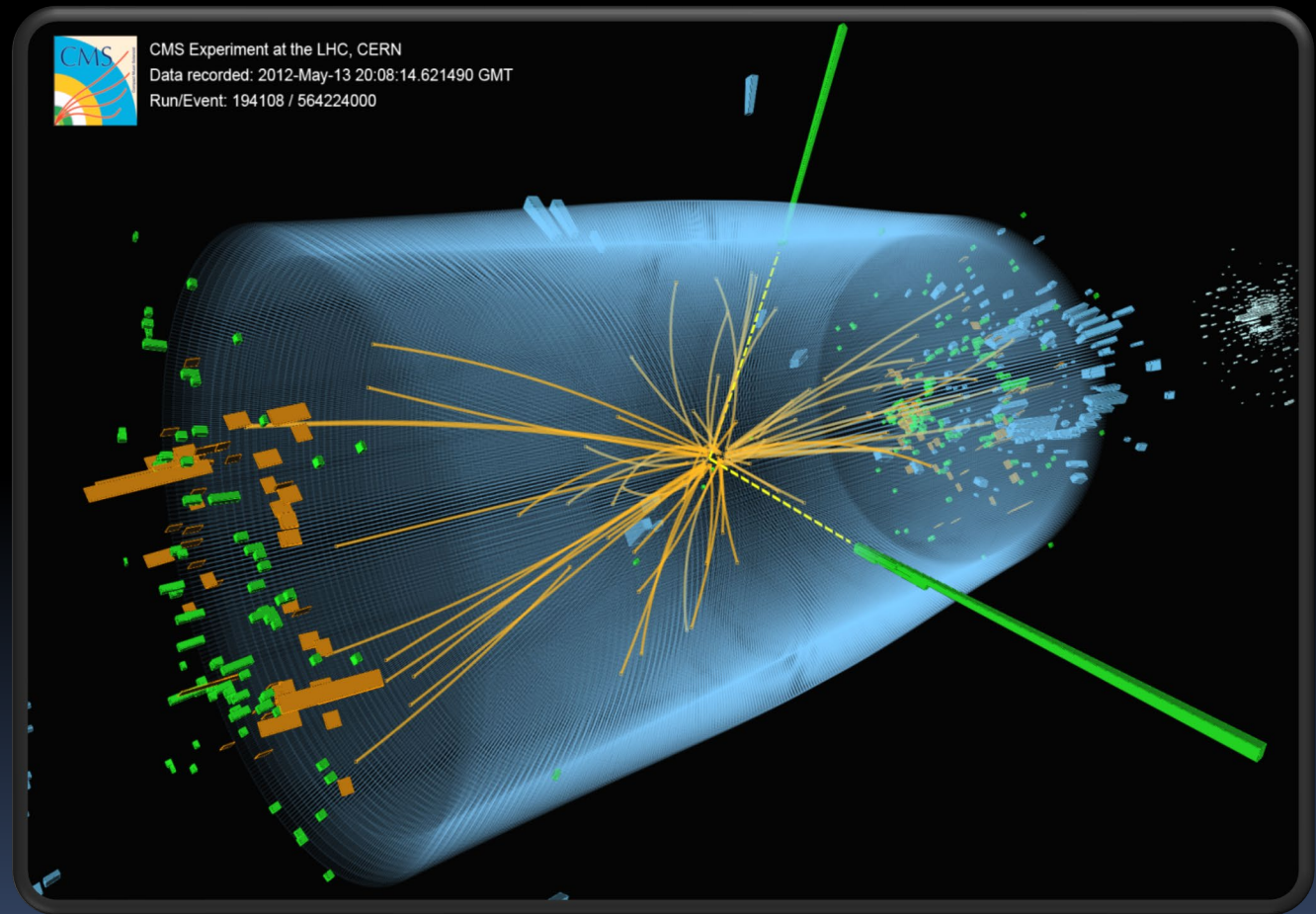

R.D.Matheus

Dentro do Átomo

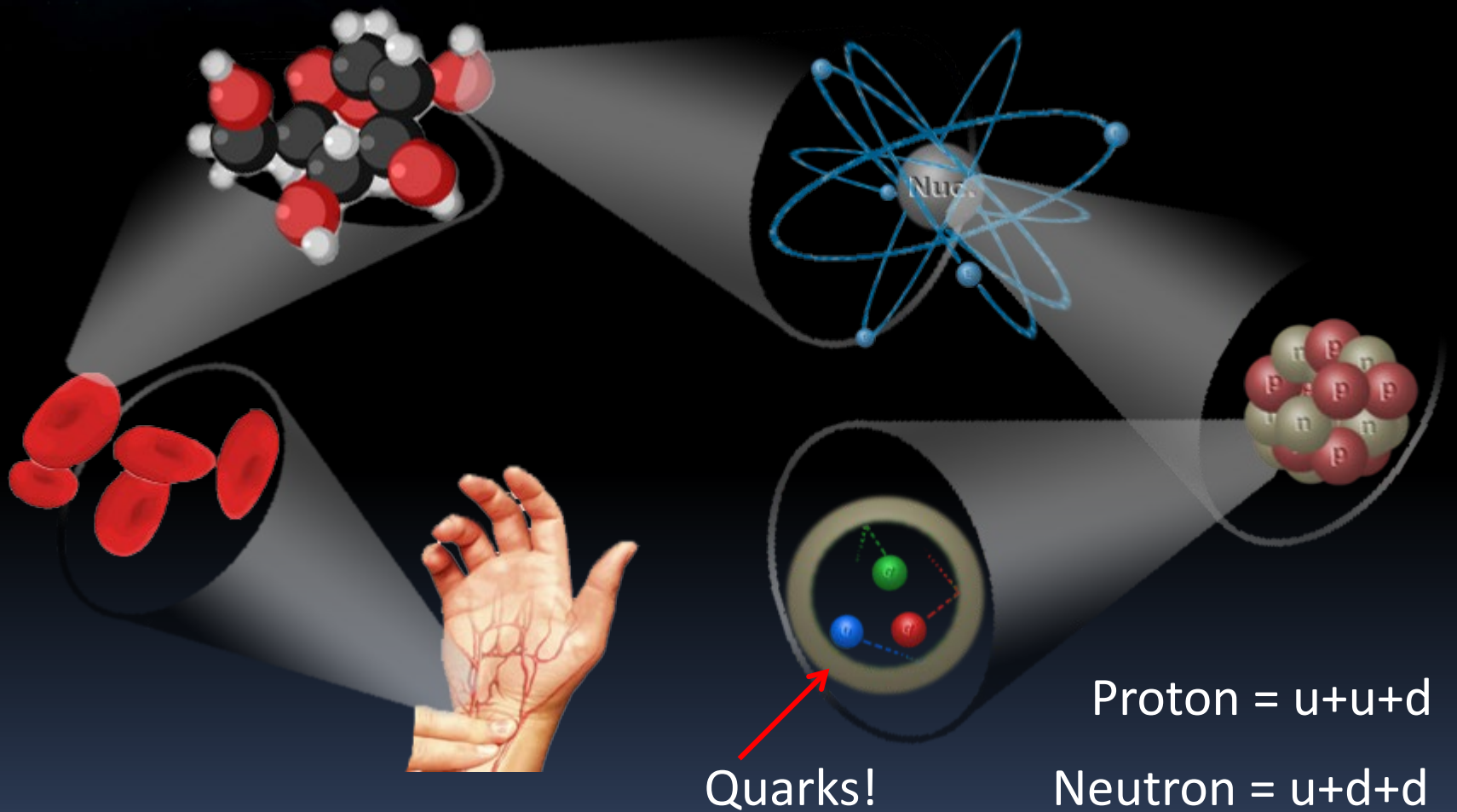

Dentro do Átomo

Um viva ao reducionismo!

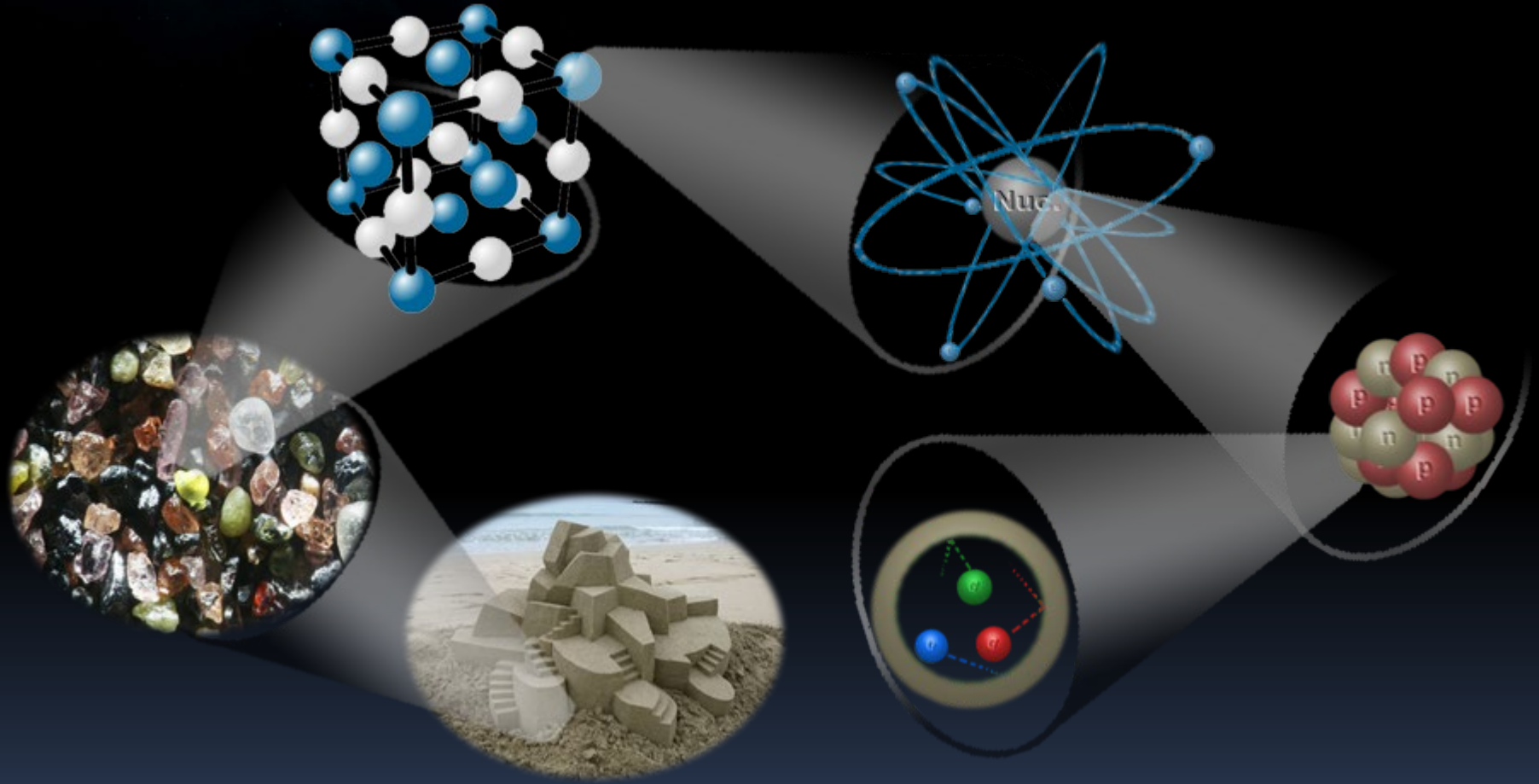

Uma tabela para os novos “átomos”

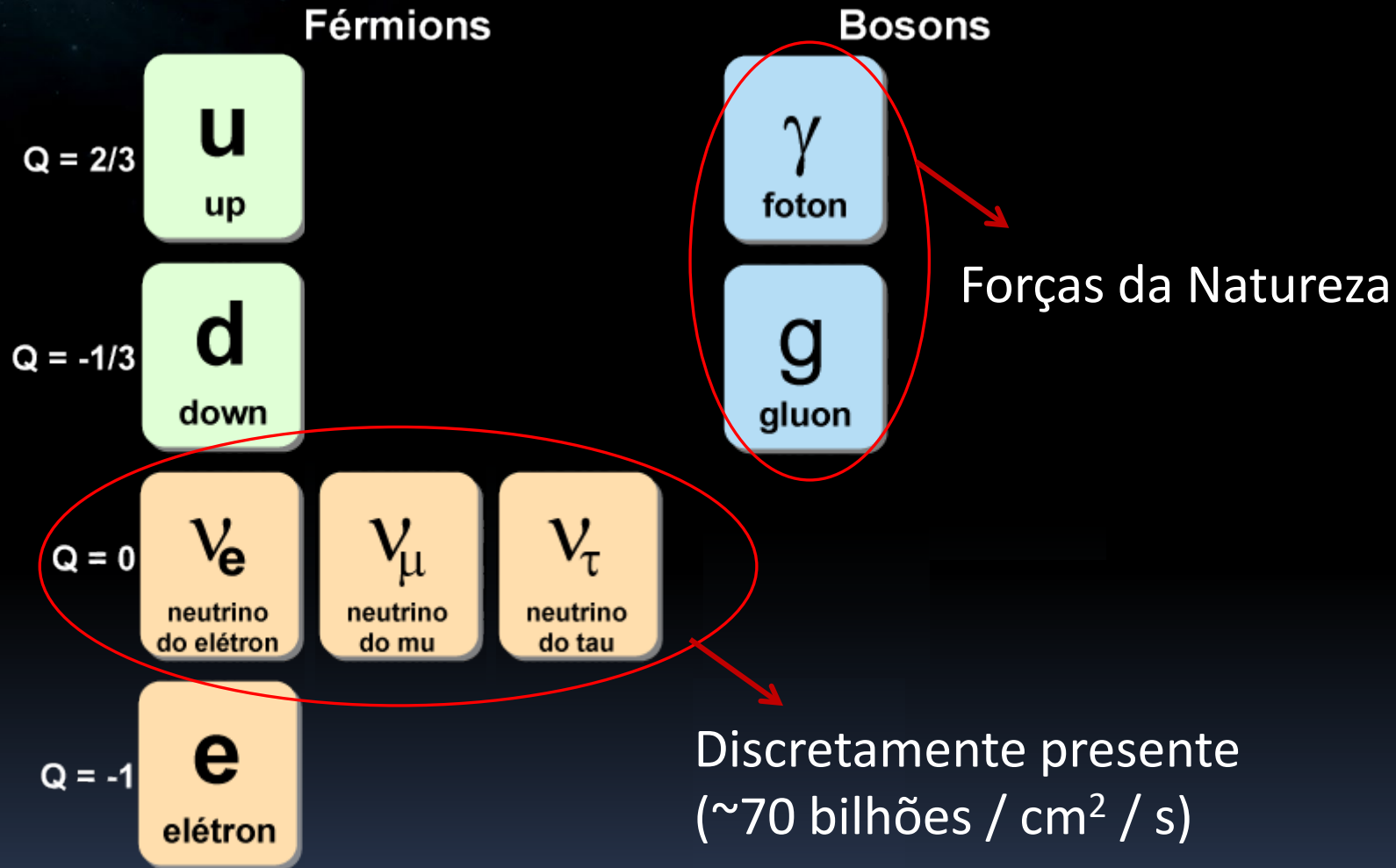

Aumenta a energia, aumenta a tabela

O MODELO PADRÃO

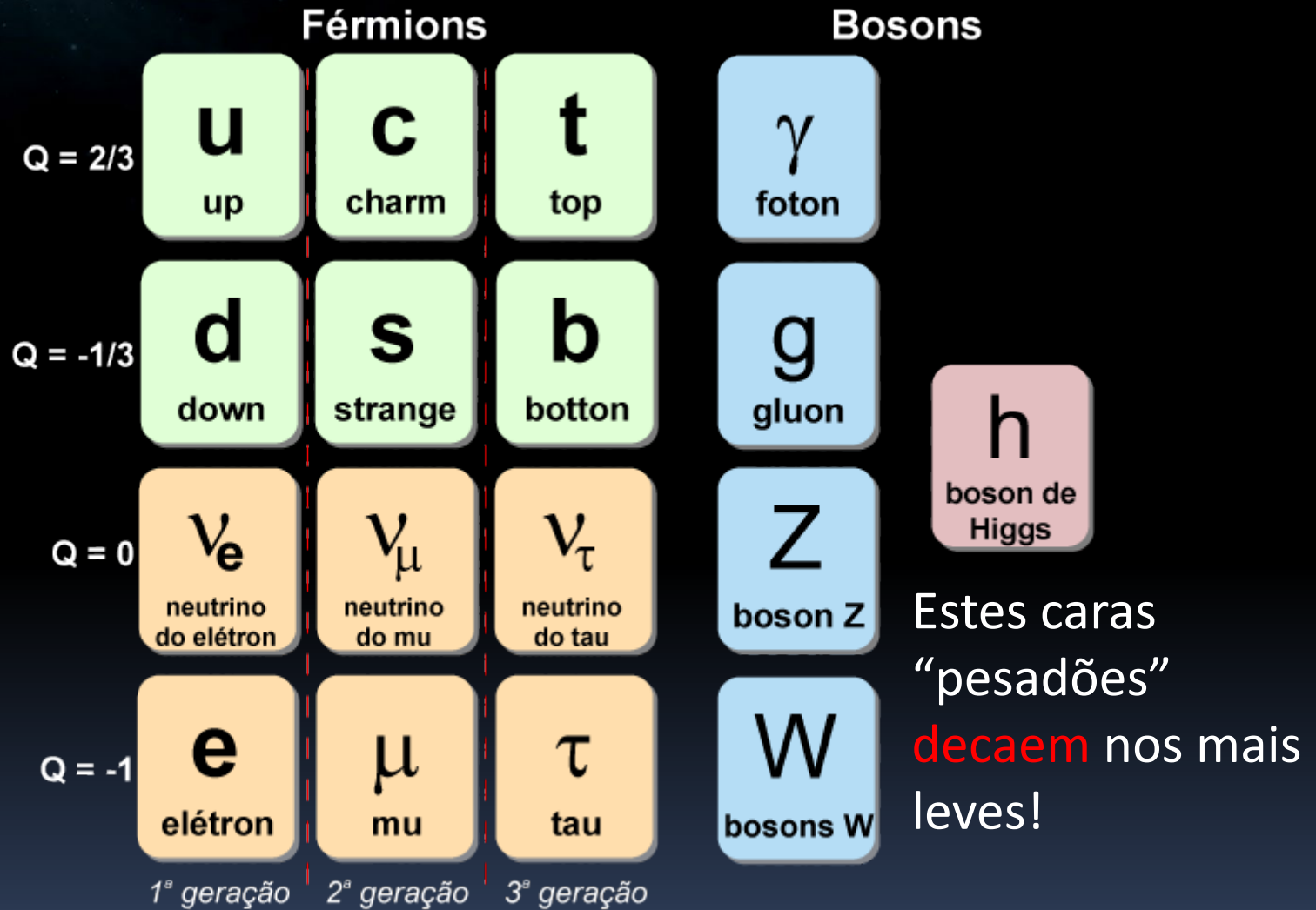



Fim de papo?

Qual era nossa pergunta mesmo?

... Ah! A menor coisa que existe.
Existe isso?

O Grande Deserto

The Estimated Size
of the Universe





A busca continua!

Obrigado pela Atenção!